

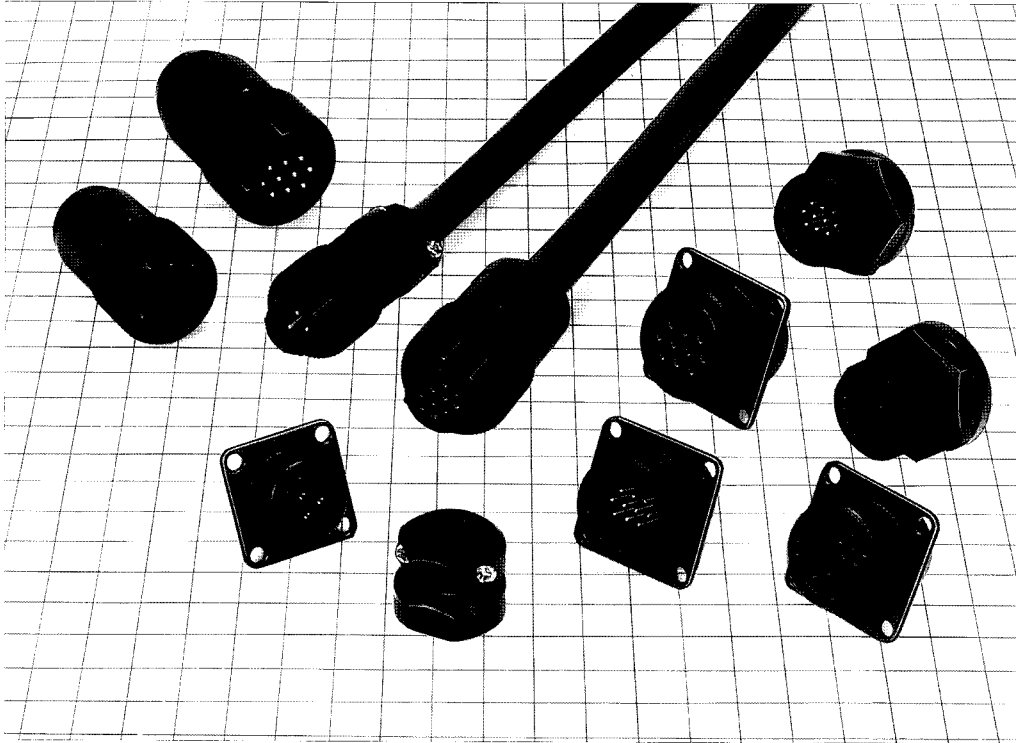

JR Series

High-performance water-proof circular connector JR-W connector



General Description

JR-W connector is a water-proof connector developed for interfaces of machine tools, communications equipment, etc. JR-W connector is also corrosion resistant so that it can be used satisfactorily even in adverse environments.

Features

- | | |
|---|--|
| (1) Water-proof structure
The connector is structured so that water will not soak into it when placed under water to a depth of 1.8 m for 48 hours. (IP67 or more) | (3) Smooth connection
Connecting part is provided with five guides to make connection very smooth. |
| (2) Outstanding corrosion resistance
Outer metal is plated with black chromium to prevent corrosion. | (4) Versatile
JR-W connector is variable in shell sizes and core numbers. Cable clamps are available in various sizes, so that various combinations can be made in accordance with application. |

Application

Machine tools, FA-related equipment, communications equipment, various electronic equipment and devices.

Material & Treatment

Part name	Material	Treatment
Shell	Aluminum alloy, brass, zinc alloy	Black chromium plating
Insulator	Synthetic resin	Black or greenish brown
Male terminal	Copper alloy	Silver plating
Female terminal	Copper alloy	Silver plating

In addition, products with varied material or treatments are available.
 Please contact your Hirose sales representative for more information.

Structure of Product No.

● Plug · Receptacle

JR 13 W P A - 3 P

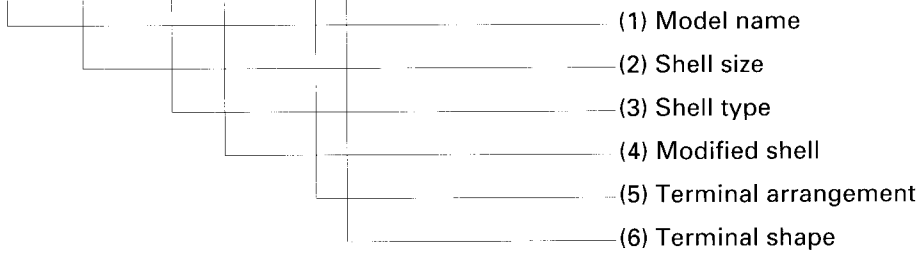

● Cord clamp

JR 13 W C C A - 4

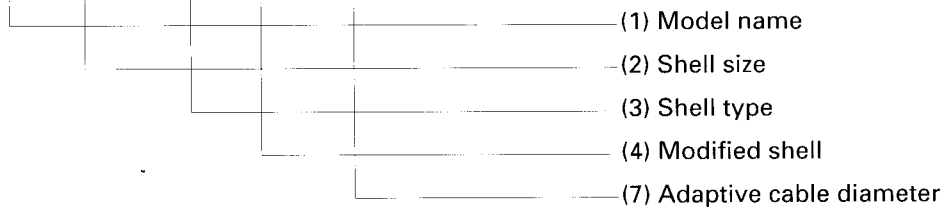

- (1) Model name: Indicates JR series.
- (2) Shell size: Indicated by the outer diameter of the shell for connecting the plug.
- (3) Shell type: Shell types are as follows.
 - WP: Water-proof plug
 - WR: Water-proof receptacle
 - WCC: Water-proof cord clamp
- (4) Modified shell: Changes in order of A, B, D, E... every time the outer sheath shape is changed. But, C, J, P and R are not used to prevent confusion.
- (5) Terminal arrangement: Indicated by the number of terminals.
- (6) Terminal shape: Identified as follows.
 - P: Male terminal
 - PC: Pressure connection type male terminal
 - S: Female terminal
 - SC: Pressure connection type female terminal
- (7) Adaptive cable diameter: Indicates the adaptive cable diameter.

Soldering type

■ Plug (water-proof type)

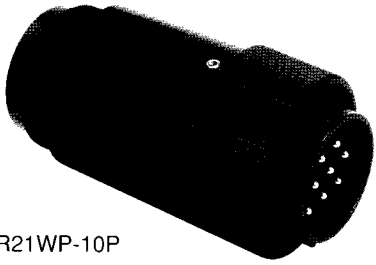

JR21WP-10P

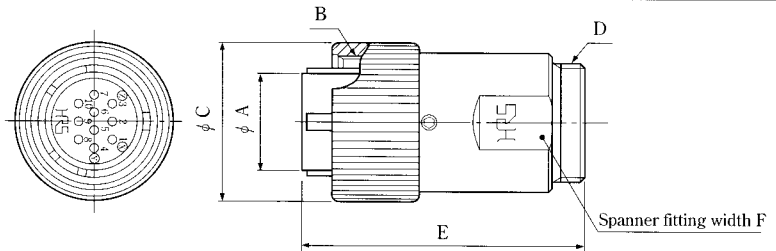

(This shape is one example.)

HRSNo.	Product No.	No. of pins	φ A	B	φ C	D	E	F
114-2001-5	JR13WP-3P	3	12.7	M18×1	21.8	M16×0.75	44.7	17
114-2002-8	JR13WP-5P	5	12.7	M18×1	21.8	M16×0.75	44.7	17
114-2003-0	JR16WP-7P	7	16.3	M22×1	21.8	M20×0.75	46.5	21
114-2004-3	JR16WP-10P	10	16.3	M22×1	25.8	M20×0.75	46.5	21
114-2005-6	JR21WP-10P	10	20.5	M26×1	29.8	M24×0.75	51	25.4
114-2006-9	JR21WP-16P	16	20.5	M26×1	29.8	M24×0.75	51	25.4
114-2007-1	JR25WP-4P	4	24.7	M30×1	33.8	M28×0.75	56	29
114-2008-4	JR25WP-5P	5	24.7	M30×1	33.8	M28×0.75	56	29
114-2009-7	JR25WP-8P	8	24.7	M30×1	33.8	M28×0.75	56	29
114-2010-6	JR25WP-16P	16	24.7	M30×1	33.8	M28×0.75	56	29
114-2011-9	JR25WP-24P	24	24.7	M30×1	33.8	M28×0.75	56	29

HRSNo.	Product No.	No. of pins	φ A	B	φ C	D	E	F
114-2012-1	JR13WP-3S	3	12.7	M18×1	21.8	M16×0.75	44.7	17
114-2013-4	JR13WP-5S	5	12.7	M18×1	21.8	M16×0.75	44.7	17
114-2014-7	JR16WP-7S	7	16.3	M22×1	25.8	M20×0.75	46.5	21
114-2015-0	JR16WP-10S	10	16.3	M22×1	25.8	M20×0.75	46.5	21
114-2016-2	JR21WP-10S	10	20.5	M26×1	29.8	M24×0.75	51	25.4
114-2017-5	JR21WP-16S	16	20.5	M26×1	29.8	M24×0.75	51	25.4
114-2018-8	JR25WP-4S	4	24.7	M30×1	33.8	M28×0.75	56	29
114-2019-0	JR25WP-5S	5	24.7	M30×1	33.8	M28×0.75	56	29
114-2020-0	JR25WP-8S	8	24.7	M30×1	33.8	M28×0.75	56	29
114-2021-2	JR25WP-16S	16	24.7	M30×1	33.8	M28×0.75	56	29
114-2022-5	JR25WP-24S	24	24.7	M30×1	33.8	M28×0.75	56	29

Note 1. Use the plug in combination with the cord clamp.

■ Receptacle (water-proof type)

● Screw type

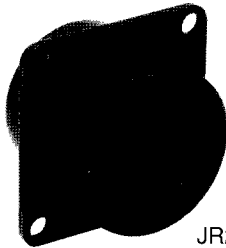

JR21WR-10S

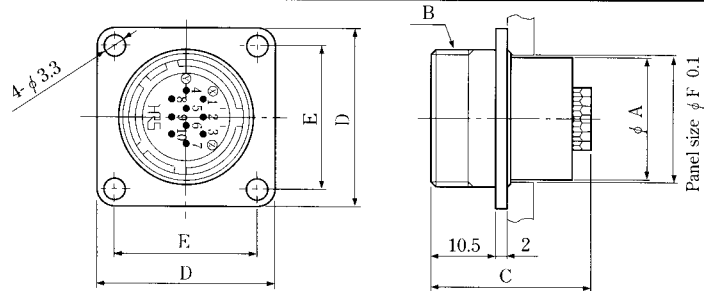

(This shape is one example.)

HRSNo.	Product No.	No. of pins	φ A	B	C	D	E	F
114-2023-8	JR13WR-3P	3	15.9	M18×1	26.6	26	20	16.3
114-2024-0	JR13WR-5P	5	15.9	M18×1	26.1	26	20	16.3
114-2025-3	JR16WR-7P	7	19.9	M22×1	26.6	29	23	20.3
114-2026-6	JR16WR-10P	10	19.9	M22×1	26.1	29	23	20.3
114-2027-9	JR21WR-10P	10	23.9	M26×1	26.6	32	26	24.3
114-2028-1	JR21WR-16P	16	23.9	M26×1	26.1	32	26	24.3
114-2029-4	JR25WR-4P	4	27.9	M30×1	28	35	29	28.3
114-2030-3	JR25WR-5P	5	27.9	M30×1	26.6	35	29	28.3
114-2031-6	JR25WR-8P	8	27.9	M30×1	26.6	35	29	28.3
114-2032-9	JR25WR-16P	16	27.9	M30×1	26.6	35	29	28.3
114-2033-1	JR25WR-24P	24	27.9	M30×1	26.1	35	29	28.3

HRSNo.	Product No.	No. of pins	φ A	B	C	D	E	φ F
114-2034-4	JR13WR-3S	3	15.9	M18×1	28	26	20	16.3
114-2035-7	JR13WR-5S	5	15.9	M18×1	27	26	20	16.3
114-2036-0	JR16WR-7S	7	19.9	M22×1	28	29	23	20.3
114-2037-2	JR16WR-10S	10	19.9	M22×1	27	29	23	20.3
114-2038-5	JR21WR-10S	10	23.9	M26×1	28	32	26	24.3
114-2039-8	JR21WR-16S	16	23.9	M26×1	27	32	26	24.3
114-2040-7	JR25WR-4S	4	27.9	M30×1	28	35	29	28.3
114-2041-0	JR25WR-5S	5	27.9	M30×1	27.8	35	29	28.3
114-2042-2	JR25WR-8S	8	27.9	M30×1	27.8	35	29	28.3
114-2043-5	JR25WR-16S	16	27.9	M30×1	28	35	29	28.3
114-2044-8	JR25WR-24S	24	27.9	M30×1	27	35	29	28.3

● Nut type

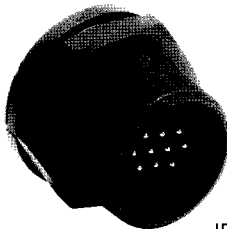

JR16WRA-10P

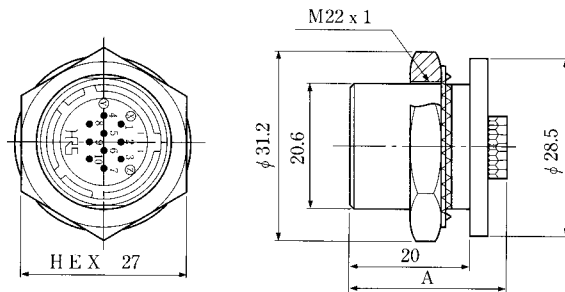

(This shape is one example.)

HRSNo.	Product No.	No. of pins	A
114-2143-0	JR16WRA-7P	7	26.6
114-2096-1	JR16WRA-10P	10	26.1
114-2144-2	JR16WRA-7S	7	28
114-2145-5	JR16WRA-10S	10	27

Fitting panel size view (1:1)

t = 1.5~6

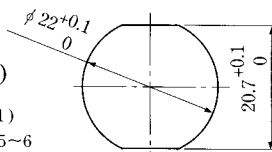

Crimp type

■ Plug (water-proof type)

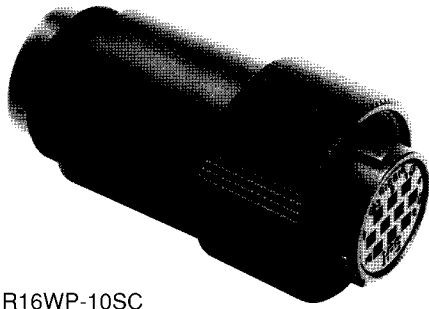

JR16WP-10SC

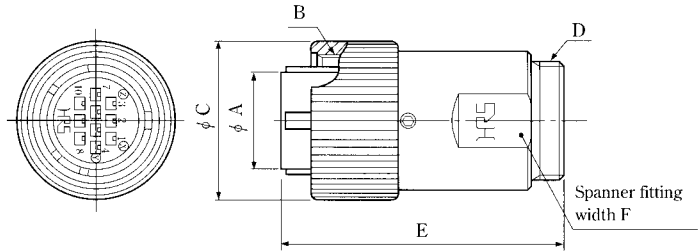

(This shape is one example.)

HRSNo.	Product No.	No. of pins	φA	B	φC	D	E	F	Contact diameter
114-2150-5	JR16WP-3PC	3	16.3	M22×1	21.8	M20×0.75	46.5	21	1.6
114-2114-1	JR16WP-10PC	10	16.3	M22×1	25.8	M20×0.75	46.5	21	1
114-2115-4	JR21WP-10PC	10	20.5	M26×1	29.8	M24×0.75	51	25.4	1.6
114-2116-7	JR21WP-16PC	16	20.5	M26×1	29.8	M24×0.75	51	25.4	1
114-2118-2	JR25WP-24PC	24	24.7	M30×1	33.8	M28×0.75	56	29	1

HRSNo.	Product No.	No. of pins	φA	B	φC	D	E	F	Contact diameter
114-2151-8	JR16WP-3SC	3	16.3	M22×1	25.8	M20×0.75	46.5	21	1.6
114-2122-0	JR16WP-10SC	10	16.3	M22×1	25.8	M20×0.75	46.5	21	1
114-2123-2	JR21WP-10SC	10	20.5	M26×1	29.8	M24×0.75	51	25.4	1.6
114-2124-5	JR21WP-16SC	16	20.5	M26×1	29.8	M24×0.75	51	25.4	1
114-2126-0	JR25WP-24SC	24	24.7	M30×1	33.8	M28×0.75	56	29	1

Note 1. Use the plug in combination with the cord clamp.

■ Receptacle (water-proof type)

● Screw type

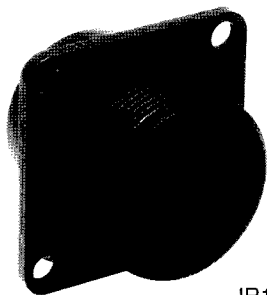

JR16WP-10RC

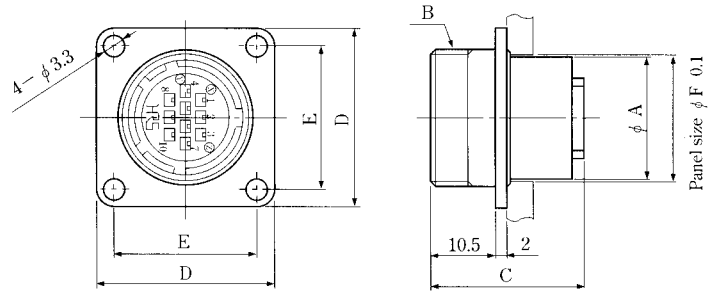

(This shape is one example.)

HRSNo.	Product No.	No. of pins	φA	B	C	D	E	φF	Contact diameter
114-2152-0	JR16WR-3PC	3	19.9	M22×1	27.6	29	23	20.3	1.6
114-2130-8	JR16WR-10PC	10	19.9	M22×1	25.1	29	23	20.3	1
114-2131-0	JR21WR-10PC	10	23.9	M26×1	27.6	32	26	24.3	1.6
114-2132-3	JR21WR-16PC	16	23.9	M26×1	25.1	32	26	24.3	1
114-2134-9	JR25WR-24PC	24	27.9	M30×1	25.1	35	29	28.3	1

HRSNo.	Product No.	No. of pins	φA	B	C	D	E	φF	Contact diameter
114-2153-3	JR16WR-3SC	3	19.9	M22×1	27.6	29	23	20.3	1.6
114-2138-0	JR16WR-10SC	10	19.9	M22×1	23.0	29	23	20.3	1
114-2139-2	JR21WR-10SC	10	23.9	M26×1	27.6	32	26	24.3	1.6
114-2140-1	JR21WR-16SC	16	23.9	M26×1	23.0	32	26	24.3	1
114-2142-7	JR25WR-24SC	24	27.9	M30×1	23.0	35	29	28.3	1

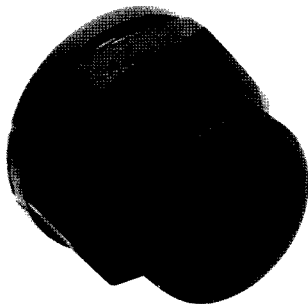

JR16WRA-10PC

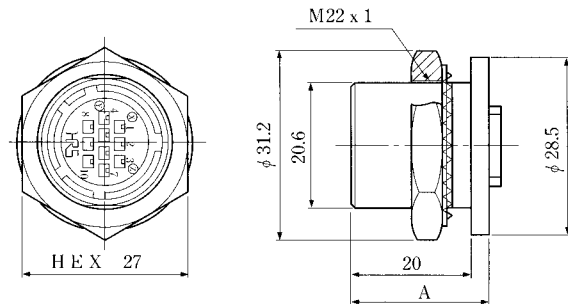

(This shape is one example.)

HRSNo.	Product No.	No. of pins	A	Contact diameter
114-2098-7	JR16WRA-3PC	3	27.6	1.6
114-2095-9	JR16WRA-10PC	10	25.1	1
114-2149-6	JR16WPRA-3SC	3	27.6	1.6
114-2148-3	JR16WPRA-10SC	10	23	1

Fitting panel size view (1:1)

t = 1.5~6

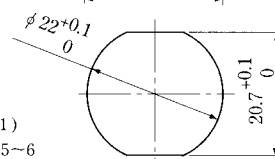

Cord Clamp

Standard type

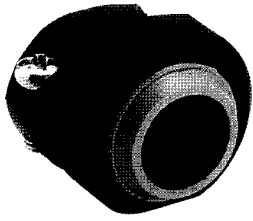

JR16WCC-12

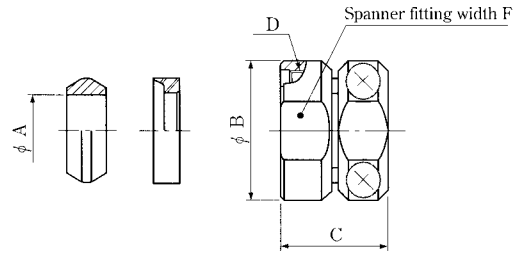

(This shape is one example.)

HRSNo.	Product No.	ϕA	ϕB	C	D	E
114-2045-0	JR13WCC-4	4	20	17	M16×0.75	17
114-2046-3	JR13WCC-5	5	20	17	M16×0.75	17
114-2047-6	JR13WCC-6	6	20	17	M16×0.75	17
114-2048-9	JR13WCC-7	7	20	17	M16×0.75	17
114-2049-1	JR13WCC-8	8	20	17	M16×0.75	17
114-2050-0	JR13WCC-9	9	20	17	M16×0.75	17
114-2051-3	JR13WCC-10	10	20	17	M16×0.75	17
114-2052-6	JR16WCC-4	4	23	17.5	M20×0.75	21
114-2053-9	JR16WCC-6	6	23	17.5	M20×0.75	21
114-2054-1	JR16WCC-8	8	23	17.5	M20×0.75	21
114-2055-4	JR16WCC-10	10	23	17.5	M20×0.75	21
114-2056-7	JR16WCC-12	12	23	17.5	M20×0.75	21

HRSNo.	Product No.	ϕA	ϕB	C	D	E
114-2057-0	JR21WCC-6	6	27	17.5	M24×0.75	25.4
114-2058-2	JR21WCC-8	8	27	17.5	M24×0.75	25.4
114-2059-5	JR21WCC-10	10	27	17.5	M24×0.75	25.4
114-2060-4	JR21WCC-12	12	27	17.5	M24×0.75	25.4
114-2061-7	JR21WCC-14	14	27	17.5	M24×0.75	25.4
114-2062-0	JR21WCC-16	16	27	17.5	M24×0.75	25.4
114-2063-2	JR25WCC-8	8	31	18	M28×0.75	29
114-2064-5	JR25WCC-10	10	31	18	M28×0.75	29
114-2065-8	JR25WCC-12	12	31	18	M28×0.75	29
114-2066-0	JR25WCC-14	14	31	18	M28×0.75	29
114-2067-3	JR25WCC-16	16	31	18	M28×0.75	29
114-2068-6	JR25WCC-18	18	31	18	M28×0.75	29

Simple type

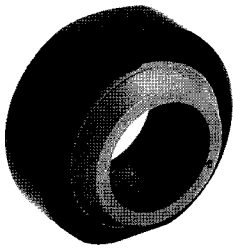

JR16WCCA-12

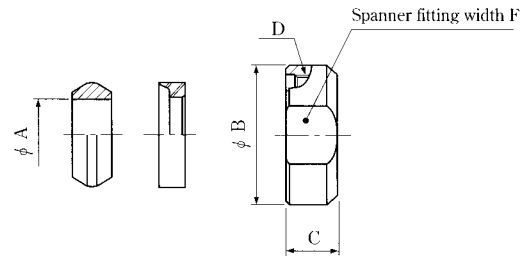

(This shape is one example.)

HRSNo.	Product No.	ϕA	ϕB	C	D	E
114-2069-9	JR13WCCA-4	4	19	7.5	M16×0.75	17
114-2070-8	JR13WCCA-5	5	19	7.5	M16×0.75	17
114-2071-0	JR13WCCA-6	6	19	7.5	M16×0.75	17
114-2072-3	JR13WCCA-7	7	19	7.5	M16×0.75	17
114-2073-6	JR13WCCA-8	8	19	7.5	M16×0.75	17
114-2074-9	JR13WCCA-9	9	19	7.5	M16×0.75	17
114-2075-1	JR13WCCA-10	10	19	7.5	M16×0.75	17
114-2076-4	JR16WCCA-4	4	23	8	M20×0.75	21
114-2077-7	JR16WCCA-6	6	23	8	M20×0.75	21
114-2078-0	JR16WCCA-8	8	23	8	M20×0.75	21
114-2079-2	JR16WCCA-10	10	23	8	M20×0.75	21
114-2080-1	JR16WCCA-12	12	23	8	M20×0.75	21

HRSNo.	Product No.	ϕA	ϕB	C	D	E
114-2081-4	JR21WCCA-6	6	27	8	M24×0.75	25.4
114-2082-7	JR21WCCA-8	8	27	8	M24×0.75	25.4
114-2083-0	JR21WCCA-10	10	27	8	M24×0.75	25.4
114-2084-2	JR21WCCA-12	12	27	8	M24×0.75	25.4
114-2085-5	JR21WCCA-14	14	27	8	M24×0.75	25.4
114-2086-8	JR21WCCA-16	16	27	8	M24×0.75	25.4
114-2087-0	JR25WCCA-8	8	31	8.5	M28×0.75	29
114-2088-3	JR25WCCA-10	10	31	8.5	M28×0.75	29
114-2089-6	JR25WCCA-12	12	31	8.5	M28×0.75	29
114-2090-5	JR25WCCA-14	14	31	8.5	M28×0.75	29
114-2091-8	JR25WCCA-16	16	31	8.5	M28×0.75	29
114-2092-0	JR25WCCA-18	18	31	8.5	M28×0.75	29

Note: The simple type cord clamp does not provide a high cable clamping force.

Contact

For contact diameter 1 Male terminal

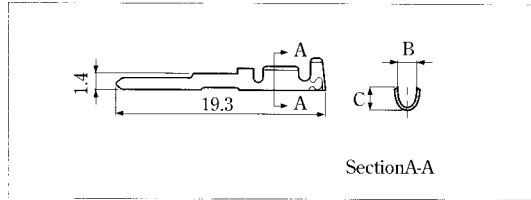

Type	HRSNo.	Product No.	B	C	Adaptive wire
Loose terminal	114-0243-3	JRC-PC2-112	1.6	2.0	AWG# 20 ~ # 24
	114-0244-6	JRC-PC2-122	1.45	1.5	AWG# 24 ~ # 28
Continuous terminal	114-0245-9	JRC-PC2-212	1.6	2.0	AWG# 20 ~ # 24
	114-0246-1	JRC-PC2-222	1.45	1.5	AWG# 24 ~ # 28

Female terminal

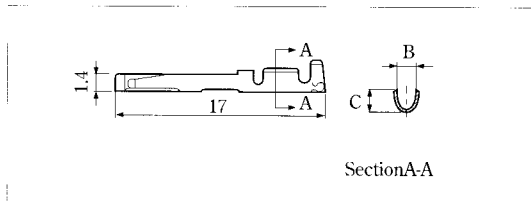

Type	HRSNo.	Product No.	B	C	Adaptive wire
Loose terminal	114-0247-4	JRC-SC2-112	1.6	2.0	AWG# 20 ~ # 24
	114-0248-7	JRC-SC2-122	1.45	1.5	AWG# 24 ~ # 28
Continuous terminal	114-0249-0	JRC-SC2-212	1.6	2.0	AWG# 20 ~ # 24
	114-0250-9	JRC-SC2-222	1.45	1.5	AWG# 24 ~ # 28

Note: The loose terminal includes 100 terminals per pack, and the continuous terminal includes 8,000 terminals per reel.

For contact diameter 1.6 Male terminal

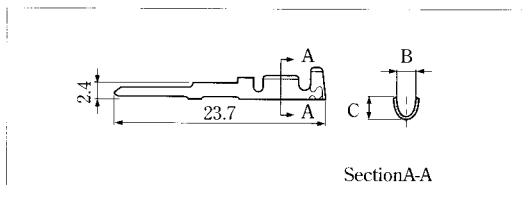

Type	HRSNo.	Product No.	B	C	Adaptive wire
Loose terminal	114-0239-6	JRC-PC-112	2.3	2.9	AWG# 16 ~ # 20
Continuous terminal	114-0240-5	JRC-PC-212	2.3	2.9	AWG# 16 ~ # 20

Female terminal

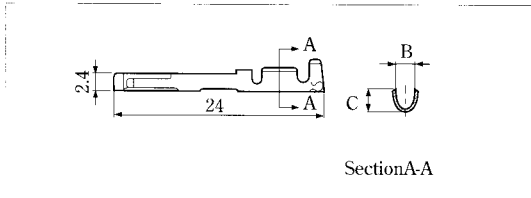

Type	HRSNo.	Product No.	B	C	Adaptive wire
Loose terminal	114-0241-8	JRC-SC-112	2.3	2.9	AWG# 16 ~ # 20
Continuous terminal	114-0242-0	JRC-SC-212	2.3	2.9	AWG# 16 ~ # 20

Note: The loose terminal includes 100 terminals per pack, and the continuous terminal includes 8,000 terminals per reel.

Applicable Tool

For contact diameter 1

Type	HRSNo.	Product No.	Adaptive contact	Adaptive wire
Manual crimp tool	150-0006-1	RM-TC-11	JRC- ^{PC} _{SC} 2-112	AWG# 20 ~ # 24
	150-0007-4	RM-TC-12	JRC- ^{PC} _{SC} 2-122	AWG# 24 ~ # 28
Automatic crimp machine		CM-105		
Pulling tool	150-0008-7	RM-TP		

For contact diameter 1.6

Type	HRSNo.	Product No.	Adaptive contact	Adaptive wire
Manual crimp tool	150-0033-4	JRC-TC-11	JRC- ^{PC} _{SC} -112	AWG# 16
	150-0034-7	JRC-TC-12	JRC- ^{PC} _{SC} -122	AWG# 18 ~ # 20
Automatic crimp machine		CM-105		
Pulling tool	150-0025-7	JRC-TP		

Hexagon wrench driver (1.27 opposite side)

HRSNo.	Product No.
150-0066-3	PB205/1.27

Connection Work Procedure (plug side)

The connection work procedure on the receptacle side is omitted because it does not need a special work procedure.

● Schematic drawing

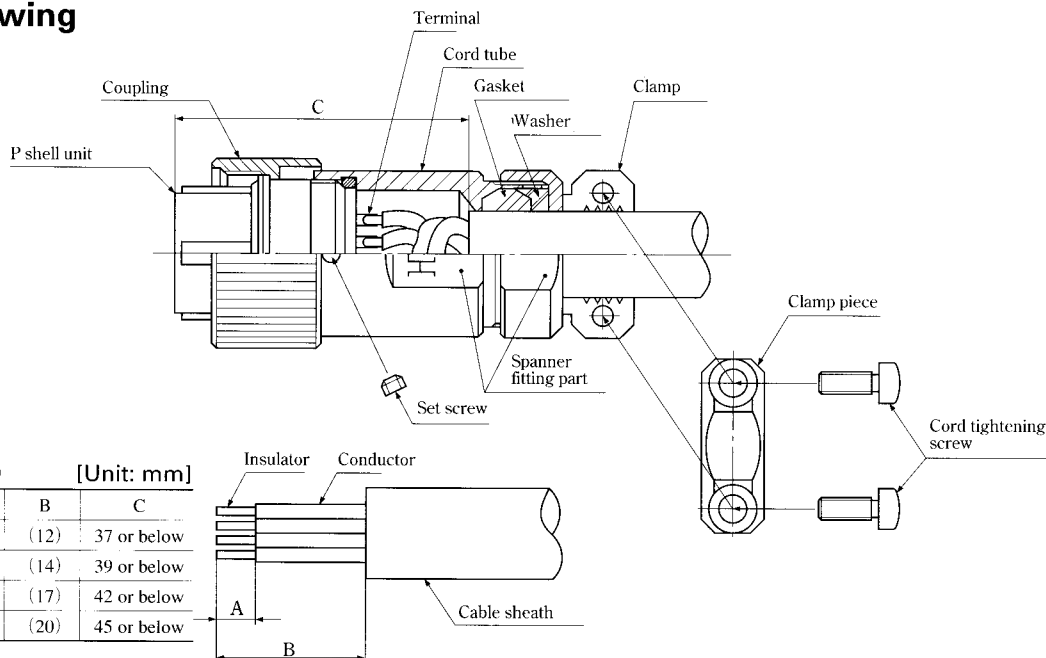

Table 1 (Solder type) [Unit: mm]

Shell size	A	B	C
13	(3)	(12)	37 or below
16	(3)	(14)	39 or below
21	(3)	(17)	42 or below
25	(3)	(20)	45 or below

Table 2 (Pressure connection type) [Unit: mm]

Shell size	Pole	A	B	C
16	3	4 ~ 4.5	(19)	39 or below
	10	3.5 ~ 4		
21	10	4 ~ 4.5	(22)	42 or below
	16	3.5 ~ 4		
25	24	3.5 ~ 4	(25)	45 or below

Table 3 [Unit: mm]

Shell size	Torque
13	2 ~ 2.5
16	3 ~ 3.5
21	4 ~ 4.5
25	5 ~ 5.5

● Work procedure

1. Disassembly of connector

- (1) To remove the plug, remove the set screw, fit a receptacle adaptive to the P shell unit to fix, and remove the cord tube.
- (2) To remove the cord clamp, remove the cord tightening screws. (Note 1)

2. Connection

2.1 Soldering type

- (1) Use the cable so that the conductor can be soldered properly into the solder cup with the cable sheath diameter adaptive to each cord clamp.
- (2) After the terminal treatment of the cable with a size given in Table 1, thread on the cable the clamp, washer, gasket, cord tube and coupling in this order and direction as shown above.
- (3) Solder to connect the conductors to the terminals of the P shell unit. Shrinkable tube is recommended to be used at the connecting part because insulating performance might deteriorate due to solder whiskers or dewing. After connecting, adjust to meet the C size. (Note 2)

2.2 Crimp type

- (1) Use the cable having the conductor and coating diameter adaptive to the crimp terminal with the cable sheath diameter adaptive to each cord clamp.
- (2) After the terminal treatment of the cable with a size given in Table 2, thread on the cable the clamp, washer, gasket, cord tube and coupling in this order and direction as shown above.
- (3) After crimping the adaptive crimp terminals to the conductor, insert the crimp terminals into the terminal holes of the P shell unit. After inserting, adjust to meet the C size. (Note 2)

3. Assembly of connector

- (1) Fit the connected P shell unit to the receptacle fixed with a vice or the like. Torque the cord tube to the level as given in Table 3.
- (2) Fit the gasket, washer and clamp. Torque the clamp to the level as given in Table 3 while preventing the cable from being rotated. And, Loctite 271 produced by Loctite Japan Co Ltd. is recommended to be applied as locking. (Note 3)
- (3) Torque the set screw to 0.2 to 0.25 N.m.
- (4) Torque the cord tightening screws (two positions) to 0.3 to 0.35 N.m. (Notes 4 and 5)

Note 1: Omitted if the cord clamp is a simple type. Note 2: Keep the size until assembling is completed. Note 3: After tightening, check water proof before using. Note 4: Check the clamp strength before using. Note 5: Omitted if the cord clamp is a simple type.

Terminal Arrangement and Major Performance

Shell size				
13				
Pole	3		5	
Voltage resistance	100V AC for 1 minute		100V AC for 1 minute	
Current capacity	10 A		5 A	
Insulation resistance	1000 M ohm or above		1000 M ohm or above	
Contact resistance	5 m ohm or below		5 m ohm or below	
Solder pot inner diameter	φ 1.7		φ 1.1	

Shell size						
16						
Pole	3		7		10	
Voltage resistance	2000V AC for 1 minute		1000V AC for 1 minute		1000V AC for 1 minute	
Current capacity	10 A		10 A		5 A (Crimp type 3 A)	
Insulation resistance	1000 M ohm or above		1000 M ohm or above		1000 M ohm or above	
Contact resistance	5 m ohm or below		5 m ohm or below		5 m ohm or below (Crimp type 10m Ω)	
Solder pot inner diameter	— (Only crimp type is available)		φ 1.7		φ 1.1	

Shell size								
21								
Pole	10				16			
Voltage resistance	1000V AC for 1 minute				1000V AC for 1 minute			
Current capacity	10 A				5 A (Crimp type 3 A)			
Insulation resistance	1000 M ohm or above				1000 M ohm or above			
Contact resistance	5 m ohm or below				5 m ohm or below (Crimp type 10m Ω)			
Solder pot inner diameter	φ 1.7				φ 1.1			

Shell size										
25										
Pole	4		5		8		16		24	
Voltage resistance	3000V AC for 1 minute		3000V AC for 1 minute		3000V AC for 1 minute		1000V AC for 1 minute		1000V AC for 1 minute	
Current capacity	30A		10A		10A		10A		5A (Crimp type 3 A)	
Insulation resistance	10,000 M ohm or above		10,000 M ohm or above		10,000 M ohm or above		1000 M ohm or above		1000 M ohm or above	
Contact resistance	5 m ohm or below		5 m ohm or below		5 m ohm or below		5 m ohm or below		5 m ohm or below (Crimp type 10m Ω)	
Solder pot inner diameter	φ 3.4		φ 1.7		φ 1.7		φ 1.7		φ 1.1	

Remarks: 1. Illustrations show the fitting faces of connectors having male terminals.
 2. The voltage resistance is indicated at a test voltage value. The regular voltage is one tenth or below of the test voltage value.

Notes in Use

1. Be sure to turn off the power to the circuit before connecting or disconnecting the connector.
2. Be sure to use the connector having female terminals on the power side to the circuit.
3. Be sure to use the connector with the screw lock activated (thoroughly tightened).
4. Use the connector as the combination of water-proof types.

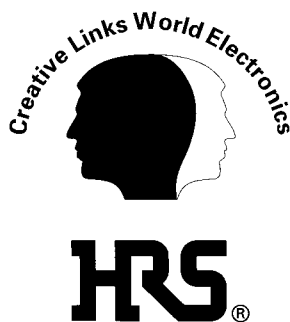

* The contents of the catalogue were in effect as of September 1996. The contents may be subject to change for improvement or the like without advance notice.

HIROSE ELECTRIC CO., LTD

5-23, OSAKI 5-CHOME, SHINAGAWA-KU, TOKYO 141, JAPAN
 PHONE: 3-3491-9741 TELE FAX: 3-3493-2933

Cat. No. IC10-1-96 Printed in Japan